

General Description

SY20518 is a wide input voltage range, high efficiency, fixed frequency buck-boost converter that operates from input voltage above, below or equal to the output voltage. It provides a power supply for system powered by either a two-cell or three-cell alkaline, Ni-Cd or Ni-MH battery, or a one-cell Li-Ion or Li-polymer battery.

SY20518 can support for 2A load current capability. It is based on a fixed frequency, pulse-width-modulation (PWM) controller using synchronous rectification to obtain maximum efficiency. The output voltage and compensation circuit can be programmed using external resistors and capacitors network. During shutdown, the load is disconnected from the battery. The device is packaged in tight QFN2x3-13.

Features

- Fixed frequency operation with battery voltage above, below or equal to the output.
- Four internal power switches to form true 4-switches buck-boost with single inductor.
- Seamless buck-boost transition.
- 2.6V to 5.5V Input Voltage Range.
- 2A continuous output current capability.
- Output disconnect at shutdown.
- Power good indicator.
- Compact package: QFN2x3-13
- Built in thermal shut down protection, hard short protection.

Ordering Information

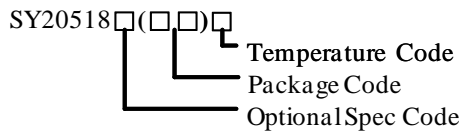

Ordering Number	Package type	Note
SY20518QOC	QFN2x3-13	----

Applications

- Palmtop Computers
- Handheld Instruments
- MP3/MP4 Players
- Digital Cameras/Camcorders
- Personal Medical Products
- High Power LED's
- All two-cell and three-cell alkaline, Ni-Cd or Ni-MH or signal-cell Li battery powered products

Typical Applications

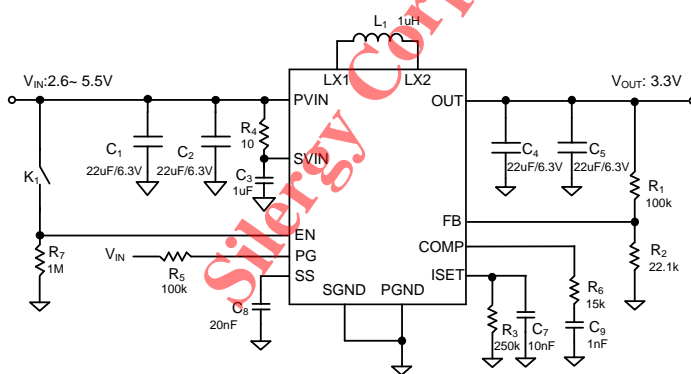

Figure 1. Schematic diagram

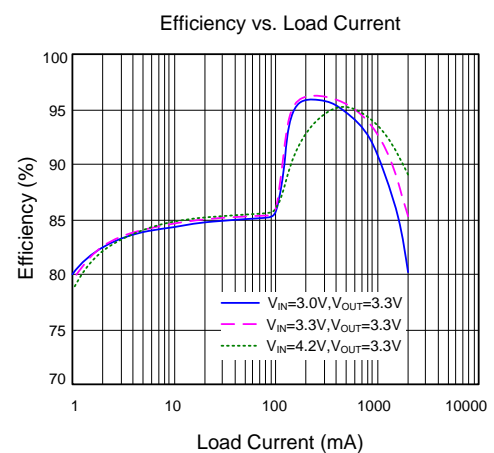
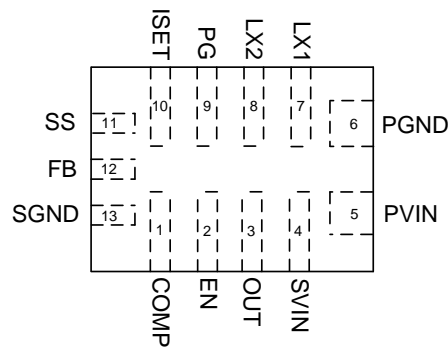

Figure 2. Efficiency Figure

Pinout (top view)

Top Mark: ZNxyz (device code: ZN, x=year code, y=week code, z=lot number code)

Pin Name	Pin Number	Description
COMP	1	External compensation for voltage loop.
EN	2	Enable control. Pull high to turn on. Internal integrated with 1M Ω pull down Resistor.
OUT	3	Output of the synchronous rectifier. Decouple this pin to GND with at least 22uF ceramic cap. Minimize the loop area formed by output cap, OUT pin and GND paddles.
SVIN	4	Signal power input pin. Decouple this pin to GND with at least 1uF ceramic cap.
PVIN	5	Power input pin. Decouple this pin to GND with at least 22uF ceramic cap. Minimize the loop area formed by input cap, PVIN pin and GND paddles.
PGND	6	Power ground pin.
LX1	7	Inductor connection 1. Connect this node to the switching node of the inductor.
LX2	8	Inductor connection 2. Connect this node to the switching node of the inductor.
PG	9	Power good indicator.
ISET	10	Apply a resistor and capacitor parallel network to sense the output average current. If V_{ISET} is lower than 0.2V, IC will go into PFM mode. Do not let it floating. Tie to ground for forced PWM operation.
SS	11	Connect this pin to a soft-start capacitor to program soft-start time.
FB	12	Output feedback pin. Connect this pin to the center point of the output resistor divider to program the output voltage.
SGND	13	Signal ground pin.

Absolute Maximum Ratings (Note 1)

OUT	-----	4 V
All Other Pins	-----	6V
Power Dissipation, P_D @ $T_A = 25\text{ }^\circ\text{C}$	-----	3W
Package Thermal Resistance (Note 2)		
θ_{JA}	-----	40 $^\circ\text{C/W}$
θ_{JC}	-----	18 $^\circ\text{C/W}$
Junction Temperature Range	-----	150 $^\circ\text{C}$
Lead Temperature (Soldering, 10 sec.)	-----	260 $^\circ\text{C}$
Storage Temperature Range	-----	-65 $^\circ\text{C}$ to 150 $^\circ\text{C}$

Recommended Operating Conditions (Note 3)

Supply Input Voltage -----	2.6V to 5.5V
Output Voltage -----	2.6V to 3.8V
Junction Temperature Range -----	-40 °C to 125 °C
Ambient Temperature Range -----	-40 °C to 85 °C

Silergy Corp. Confidential Prepared For Symmetrix

Electrical Characteristics

($V_{IN} = 4.2V$, $V_{OUT} = 3.3V$, $L = 1\mu H$, $C_{OUT} = 22\mu F \times 2$, $T_A = 25^\circ C$, $I_{OUT} = 1A$ unless otherwise specified)

Parameter	Symbol	Test Conditions	Min	Typ	Max	Unit
Input Voltage Range	V_{IN}		2.6		5.5	V
Output Voltage Range	V_{OUT}		2.6		3.8	V
Quiescent Current	I_Q	$I_{OUT}=0$, $EN=1$, $ISET=250k\Omega$, $FB=105\% * V_{REF}$		60	100	μA
Shutdown Current	I_{SHDN}	$EN=0$		0.1	1	μA
Feedback Reference Voltage	V_{REF}		0.591	0.6	0.609	V
NFET $R_{DS(ON)}$	$R_{DS(ON)1}$			50		m Ω
PFET $R_{DS(ON)}$	$R_{DS(ON)2}$			50		m Ω
Input Peak Current Limit	I_{LIM}		4.5	5		A
Output Negative Current Limit	I_{NEG}			-1		A
Soft-start current	I_{SS}	Soft-start time: $t_{ss} = \frac{0.7V}{I_{ss}} \times C_{ss}$		5		μA
EN rising threshold	V_{ENH}		1.5			V
EN falling threshold	V_{ENL}				0.4	V
Input UVLO rising threshold	V_{UVLO}			2.45	2.55	V
UVLO hysteresis	V_{HYS}			0.2		V
PG rising threshold	$V_{FB,HV}$			0.48		V
PG under-voltage threshold	$V_{FB,LV}$			0.48		V
PG over voltage threshold	$V_{FB,OV}$			0.72		V
Output current sense	I_{SET}	$I_{OUT}=1A$		5		μA
Output Voltage Over Protection	V_{OVP}			125		%
OVP protection delay time	$T_{OVP, delay}$			16		μs
ISET pin threshold for PFM mode	V_{PFM}			0.2		V
Oscillator Frequency	F_{OSC}	$I_{OUT}=1.0A$	0.8	1.0	1.2	MHz
Min Duty Cycle		Boost & Buck		10		%
Max Duty Cycle		Boost & Buck		90		%
Thermal Shutdown Temperature	T_{SD}			150		$^\circ C$
Thermal Shutdown Hysteresis	T_{HYS}			15		$^\circ C$

Note 1: Stresses beyond the “Absolute Maximum Ratings” may cause permanent damage to the device. These are stress ratings only. Functional operation of the device at these or any other conditions beyond those indicated in the operational sections of the specification is not implied. Exposure to absolute maximum rating conditions for extended periods may affect device reliability.

Note 2: θ_{JA} is measured in the natural convection at $T_A = 25^\circ C$ on a low effective single layer thermal conductivity test board of JEDEC 51-3 thermal measurement standard. Paddle of QFN2x3-13 package is the case position for θ_{JC} measurement.

Note 3: The device is not guaranteed to function outside its operating conditions.

Typical Performance Characteristics

Efficiency vs. Load Current

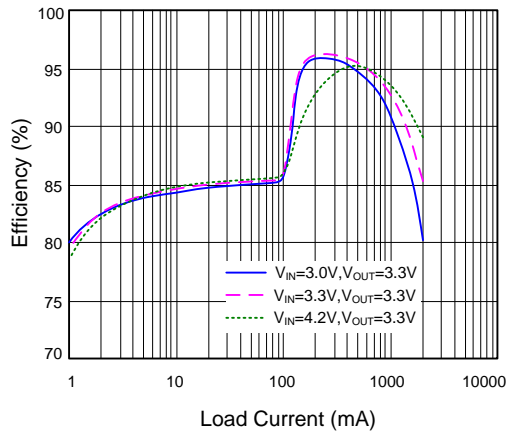

Output Ripple

($V_{IN}=3.0V, V_{OUT}=3.3V, I_{OUT}=0A$)

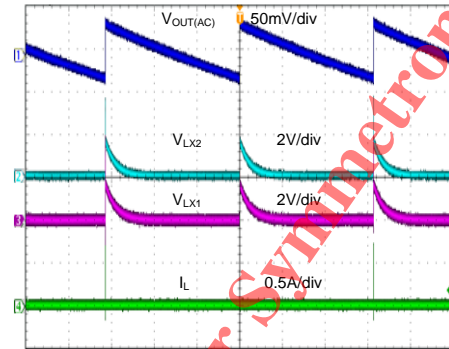

Time (10ms/div)

Output Ripple

($V_{IN}=3.0V, V_{OUT}=3.3V, I_{OUT}=2A$)

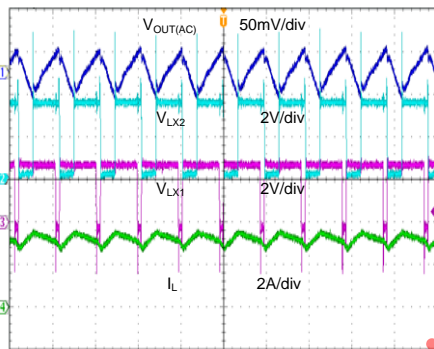

Time (1µs/div)

Output Ripple

($V_{IN}=4.2V, V_{OUT}=3.3V, I_{OUT}=0A$)

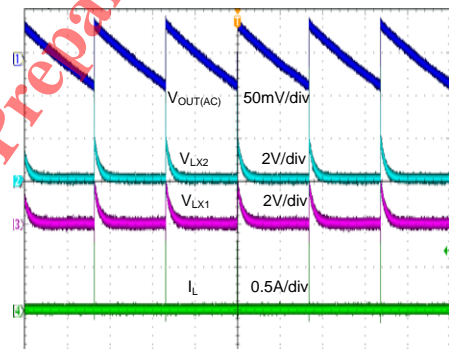

Time (20ms/div)

Output Ripple

($V_{IN}=4.2V, V_{OUT}=3.3V, I_{OUT}=2A$)

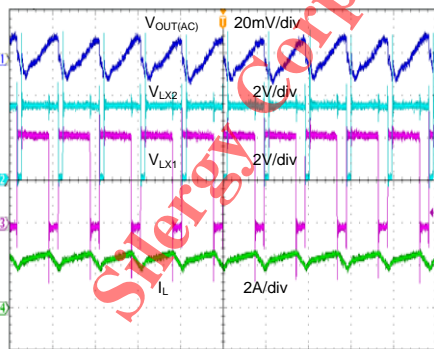

Time (1µs/div)

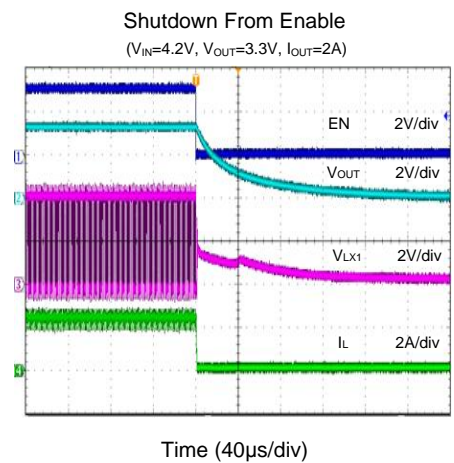
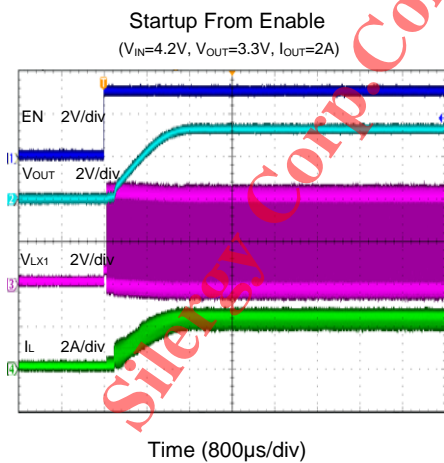
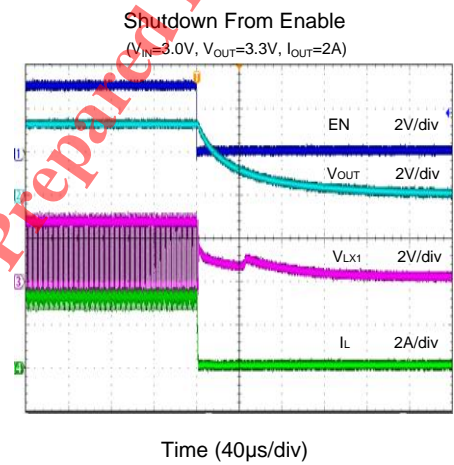
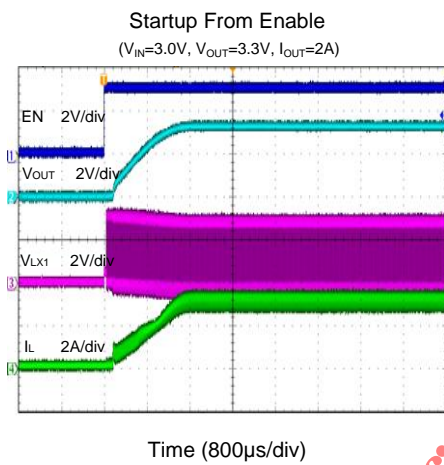
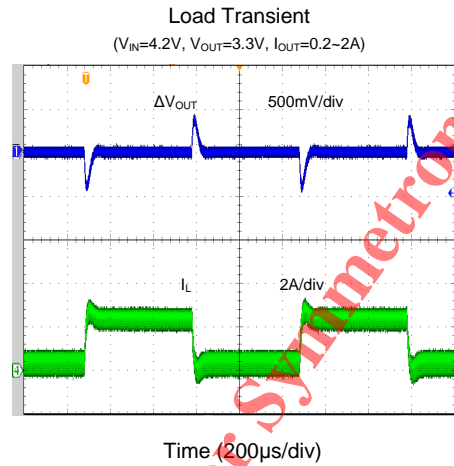
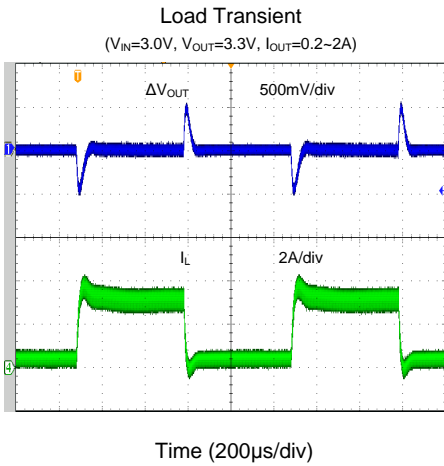

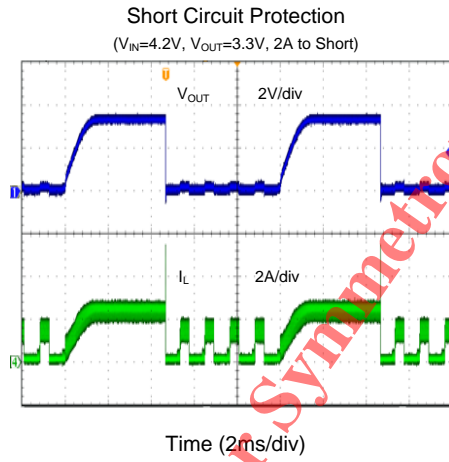
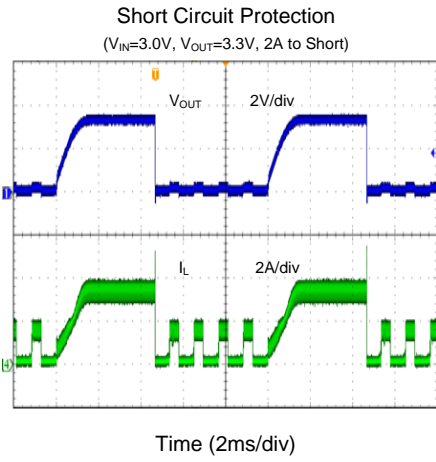

Silergy Corp. Confidential Prepared For Symmetron

Operation

SY20518 is a wide input voltage range, high efficiency, fixed frequency buck-boost converter that operates from input voltage above, below or equal to the output voltage. It provides a power supply for system powered by either a two-cell or three-cell alkaline, Ni-Cd or Ni-MH battery, or a one-cell Li-Ion or Li-polymer battery.

SY20518 can support for 2A load current capability. It is based on a fixed frequency, pulse-width-modulation (PWM) controller using synchronous rectification to obtain maximum efficiency. The output voltage and compensation circuit can be programmed using external resistors and capacitors network. During shutdown, the load is disconnected from the battery. The device is packaged in tight QFN2x3-13.

Applications Information

Because of the high integration in SY20518, the application circuit based on this regulator IC is rather simple. Only input capacitor C_{IN} , output capacitor C_{OUT} , inductor L and feedback resistors (R_1 and R_2) need to be selected for the targeted applications.

Feedback resistor divider R1 and R2

Choose R_1 and R_2 to program the proper output voltage. To minimize the power consumption under light load, it is desirable to choose large resistance values for both R_1 and R_2 . A value between 10k and 1M is recommended for both resistors. If $R_1=100k$ is chosen, then R_2 can be calculated to be:

$$R_2 = \frac{0.6R_1}{V_{OUT} - 0.6} (\Omega)$$

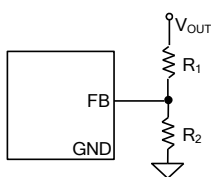

Input capacitor C_{IN}

With the maximum load current at 2A, a typical X5R or better grade ceramic capacitor with 6.3V rating and greater than 22 μ F capacitors can handle this ripple current well. To minimize the potential noise problem, place this ceramic capacitor really close to the V_{IN} and GND pins. Care should be taken to minimize the loop area formed by C_{IN} , and V_{IN}/GND pins.

Output capacitor C_{OUT}

Both steady state ripple and transient requirements must be taken into account when selecting this capacitor. For the best performance, it is recommended to use X5R or better grade ceramic capacitor with 6.3V rating and more than two 22 μ F capacitors.

Output inductor L:

There are several considerations in choosing this inductor.

- 1) Choose the inductance to provide the desired ripple current. It is suggested to choose the ripple current to be about 40% of the maximum average input current. The inductance is calculated as:

$$L = \frac{V_{OUT}(1 - V_{OUT}/V_{IN_MAX})}{F_{SW} \times I_{OUT_MAX} \times 40\%} (H)$$

where F_{SW} is the switching frequency and I_{OUT_MAX} is the maximum load current.

SY20518 is less sensitive to the ripple current variations. Consequently, the final choice of inductance can be slightly off the calculation value without significantly impacting the performance.

- 2) The saturation current rating of an inductor must be selected to guarantee an adequate margin to the peak inductor current under full load conditions. The maximum peak current happens under minimum input voltage condition.

$$I_{SAT_MIN} > \left(\frac{V_{OUT}}{V_{IN_MIN}} \right) \times I_{OUT_MAX} + \frac{V_{IN_MIN}}{V_{OUT}} \frac{(V_{OUT} - V_{IN_MIN})}{2 \times F_{SW} \times L}$$

- 3) The DCR of the inductor and the core loss at the switching frequency must be low enough to achieve the desired efficiency requirement. It is desirable to choose an inductor with $DCR < 15m\Omega$ to achieve a good overall efficiency.

Enable Operation

Pulling the EN pin low (<0.4V) will shut down the device. During shutdown, the SY20518 shutdown current drops to lower than 0.1 μ A. Driving the EN pin high (>1.5V) will turn on the IC again.

Soft Start Programming

SY20518 provides an external soft-start pin that gradually raises the output voltage. The soft-start time can be programmed by the external capacitor across SS pin and GND. The soft start time is calculated as:

$$t_{ss} = \frac{0.7}{I_{ss}} \times C_{ss}$$

If a 20nF capacitor is used, the typical soft-start time will be 2.8ms. Don't leave SS pin floating.

A separated 1uF ceramic cap is strongly recommended to decouple SVIN pin to GND.

Layout Design:

To achieve a higher efficiency and better noise immunity, following components should be placed close to the IC: C_{IN} , C_{OUT} , L, R_1 and R_2 .

1) It is desirable to maximize the PCB copper area connecting to GND pin to achieve the best thermal and noise performance. Reasonable vias are suggested to be placed underneath the ground pad to enhance the soldering quality and thermal performance.

2) SVIN is the power supply pin for the internal control circuit. Don't connect SVIN pin to PVIN pin directly.

3) The decoupling capacitor of VIN must be placed close enough to the VIN pin and GND pins. The loop area formed by the input capacitors, VIN pin and GND pins must be minimized.

4) The PCB copper area associated with LX pin must be minimized to improve the noise immunity.

5) The components R_1 , R_2 and the trace connecting to the FB/OUT pin must NOT be adjacent to the LX node on the PCB layout to minimize the noise coupling to FB/OUT pin.

PCB layout Suggestion

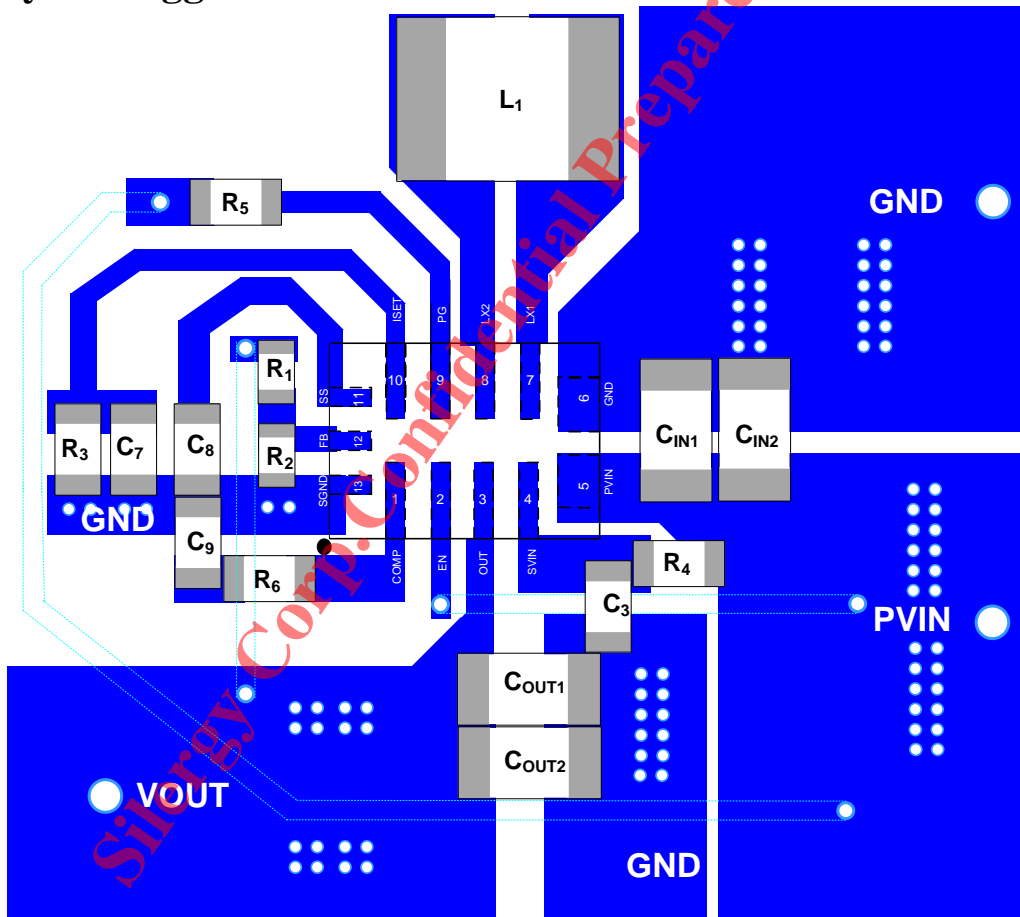

QFN2x3-13 Package Outline Drawing

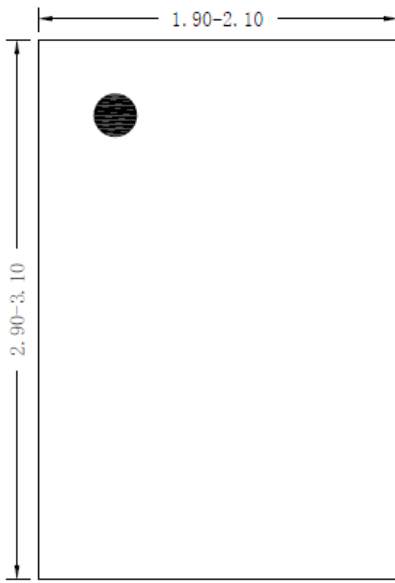

Top View

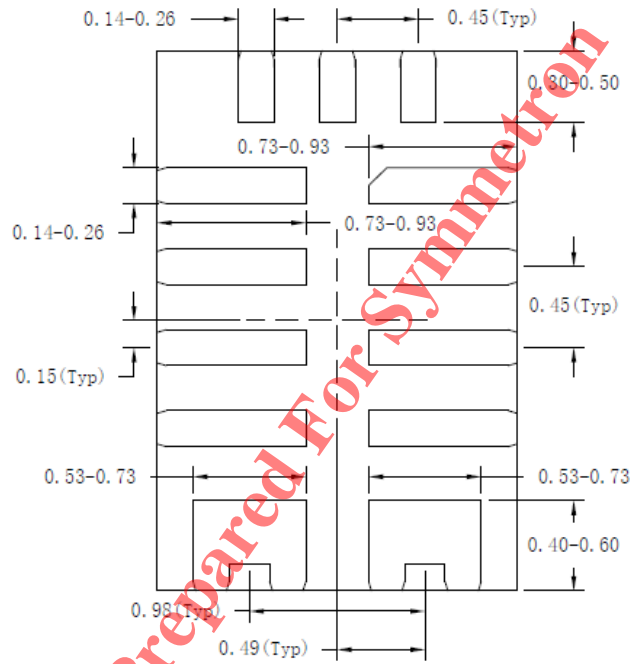

Bottom View

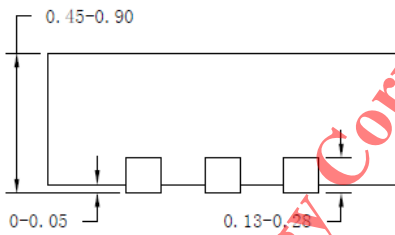

Side View

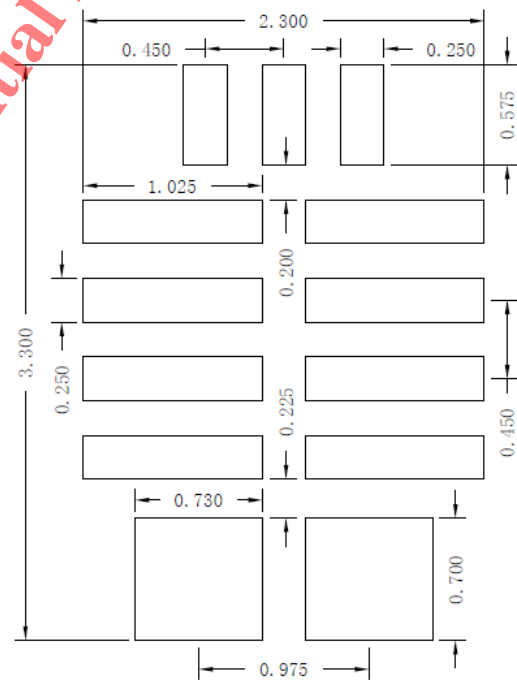

Recommended PCB layout
(Reference Only)

Notes: All dimension in millimeter and exclude mold flash & metal burr.

Taping & Reel Specification

1. QFN2x3-13 taping orientation

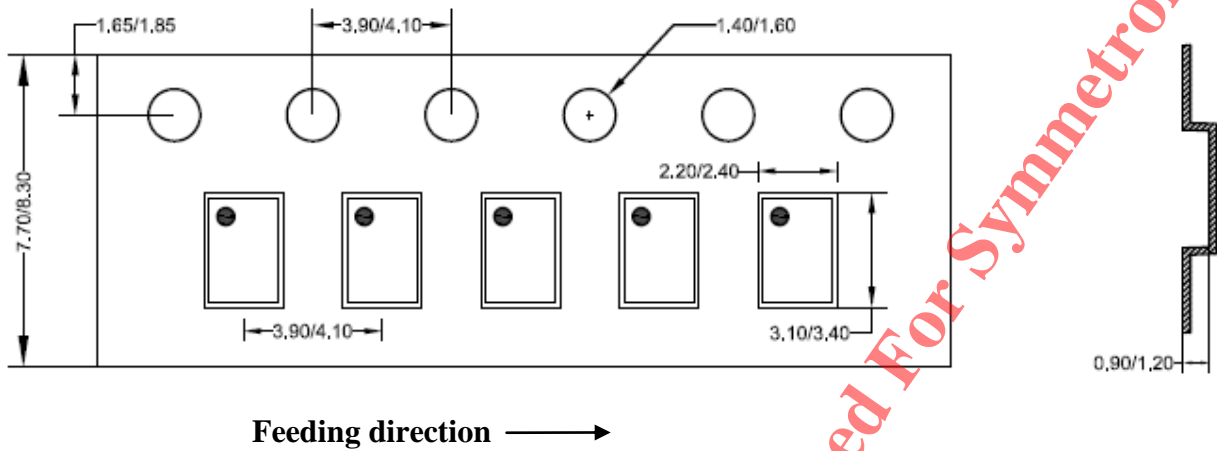

2. Carrier Tape & Reel specification for packages

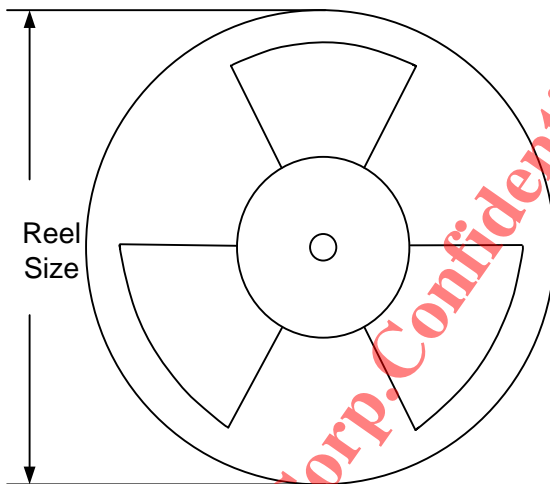

Package type	Tape width (mm)	Pocket pitch(mm)	Reel size (Inch)	Trailer length(mm)	Leader length (mm)	Qty per reel
QFN2x3	8	4	7"	400	160	3000

3. Others: NA

IMPORTANT NOTICE

- 1. Right to make changes.** Silergy and its subsidiaries (hereafter Silergy) reserve the right to change any information published in this document, including but not limited to circuitry, specification and/or product design, manufacturing or descriptions, at any time and without notice. This document supersedes and replaces all information supplied prior to the publication hereof. Buyers should obtain the latest relevant information before placing orders and should verify that such information is current and complete. All semiconductor products are sold subject to Silergy's standard terms and conditions of sale.
- 2. Applications.** Application examples that are described herein for any of these products are for illustrative purposes only. Silergy makes no representation or warranty that such applications will be suitable for the specified use without further testing or modification. Buyers are responsible for the design and operation of their applications and products using Silergy products. Silergy or its subsidiaries assume no liability for any application assistance or designs of customer products. It is customer's sole responsibility to determine whether the Silergy product is suitable and fit for the customer's applications and products planned. To minimize the risks associated with customer's products and applications, customer should provide adequate design and operating safeguards. Customer represents and agrees that it has all the necessary expertise to create and implement safeguards which anticipate dangerous consequences of failures, monitor failures and their consequences, lessen the likelihood of failures that might cause harm and take appropriate remedial actions. Silergy assumes no liability related to any default, damage, costs or problem in the customer's applications or products, or the application or use by customer's third-party buyers. Customer will fully indemnify Silergy, its subsidiaries, and their representatives against any damages arising out of the use of any Silergy components in safety-critical applications. It is also buyers' sole responsibility to warrant and guarantee that any intellectual property rights of a third party are not infringed upon when integrating Silergy products into any application. Silergy assumes no responsibility for any said applications or for any use of any circuitry other than circuitry entirely embodied in a Silergy product.
- 3. Limited warranty and liability.** Information furnished by Silergy in this document is believed to be accurate and reliable. However, Silergy makes no representation or warranty, expressed or implied, as to the accuracy or completeness of such information and shall have no liability for the consequences of use of such information. In no event shall Silergy be liable for any indirect, incidental, punitive, special or consequential damages, including but not limited to lost profits, lost savings, business interruption, costs related to the removal or replacement of any products or rework charges, whether or not such damages are based on tort or negligence, warranty, breach of contract or any other legal theory. Notwithstanding any damages that customer might incur for any reason whatsoever, Silergy' aggregate and cumulative liability towards customer for the products described herein shall be limited in accordance with the Standard Terms and Conditions of Sale of Silergy.
- 4. Suitability for use.** Customer acknowledges and agrees that it is solely responsible for compliance with all legal, regulatory and safety-related requirements concerning its products, and any use of Silergy components in its applications, notwithstanding any applications-related information or support that may be provided by Silergy. Silergy products are not designed, authorized or warranted to be suitable for use in life support, life-critical or safety-critical systems or equipment, nor in applications where failure or malfunction of an Silergy product can reasonably be expected to result in personal injury, death or severe property or environmental damage. Silergy assumes no liability for inclusion and/or use of Silergy products in such equipment or applications and therefore such inclusion and/or use is at the customer's own risk.
- 5. Terms and conditions of commercial sale.** Silergy products are sold subject to the standard terms and conditions of commercial sale, as published at <http://www.silergy.com/stdterms>, unless otherwise agreed in a valid written individual agreement specifically agreed to in writing by an authorized officer of Silergy. In case an individual agreement is concluded only the terms and conditions of the respective agreement shall apply. Silergy hereby expressly objects to and denies the application of any customer's general terms and conditions with regard to the purchase of Silergy products by the customer.
- 6. No offer to sell or license.** Nothing in this document may be interpreted or construed as an offer to sell products that is open for acceptance or the grant, conveyance or implication of any license under any copyrights, patents or other industrial or intellectual property rights. Silergy makes no representation or warranty that any license, either express or implied, is granted under any patent right, copyright, mask work right, or other intellectual property right. Information published by Silergy regarding third-party products or services does not constitute a license to use such products or services or a warranty or endorsement thereof. Use of such information may require a license from a third party under the patents or other intellectual property of the third party, or a license from Silergy under the patents or other intellectual property of Silergy.

For more information, please visit: www.silergy.com

© 2018 Silergy Corp.

All Rights Reserved.