

0.9° Size 57mm High torque Hybrid Stepping Motors

● General Specification for High Torque Hybrid Stepping Motor

Item	Specifications
Step Angle	0.9°
Step Angle Accuracy	± 5% (full step, no load)
Resistance Accuracy	± 10%
Inductance Accuracy	± 20%
Temperature Rise	80°C Max.(rated current,2 phase on)
Ambient Temperature	-20°C~+50°C
Insulation Resistance	100M Ω Min. ,500VDC
Dielectric Strength	500VAC for one minute
Shaft Radial Play	0.02Max. (450 g-load)
Shaft Axial Play	0.08Max. (450 g-load)
Max. radial force	75N (20mm from the flange)
Max. axial force	15N
Rotation	CW(See from Front Flange)

● Size 57mm High Torque Hybrid Stepping Motor Specifications

Model No.		Rated Voltage	Current /Phase	Resistance /Phase	Inductance /Phase	Holding Torque	# of Leads	Rotor Inertia	Weight	Detent Torque	Operating Curve	Length
Single Shaft	Double Shaft	V	A	Ω	mH	kg-cm		g-cm ²	kg	kg-cm		mm
FL57STH39-1006MA	FL57STH39-1006MB	5.7	1	5.7	5.4	3.9	6	120	0.45	0.21	a	39
FL57STH39-2006MA	FL57STH39-2006MB	2.8	2	1.4	1.4						b	
FL57STH39-3006MA	FL57STH39-3006MB	1.9	3	0.63	0.6						c	
FL57STH39-2804MA	FL57STH39-2804MB	2	2.8	0.7	1.4	5.5	4				d	
FL57STH56-1006MA	FL57STH56-1006MB	7.4	1	7.4	10	9.0	6	300	0.7	0.4	e	56
FL57STH56-2006MA	FL57STH56-2006MB	3.6	2	1.8	2.5						f	
FL57STH56-3006MA	FL57STH56-3006MB	2.3	3	0.75	1.1						g	
FL57STH56-2804MA	FL57STH56-2804MB	2.5	2.8	0.9	2.5	12.6	4				h	
FL57STH76-1006MA	FL57STH76-1006MB	8.6	1	8.6	14	13.5	6	480	1	0.68	i	76
FL57STH76-2006MA	FL57STH76-2006MB	4.5	2	2.25	3.6						j	
FL57STH76-3006MA	FL57STH76-3006MB	3	3	1	1.6						k	
FL57STH76-2804MA	FL57STH76-2804MB	3.2	2.8	1.13	3.6	18.9	4				l	

● Dimension

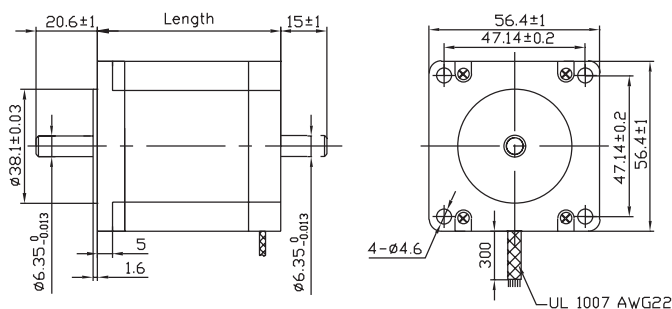

Wiring Diagram

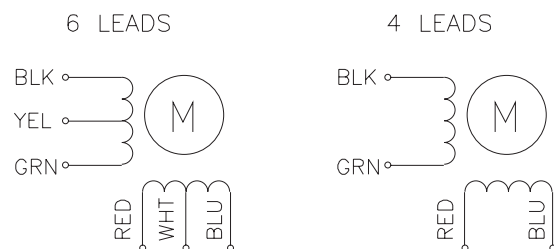

0.9° Size 57mm High torque Hybrid Stepping Motors

● Pull out Torque Curve

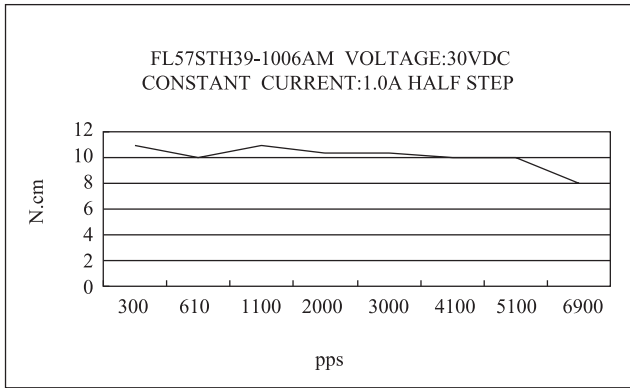

a

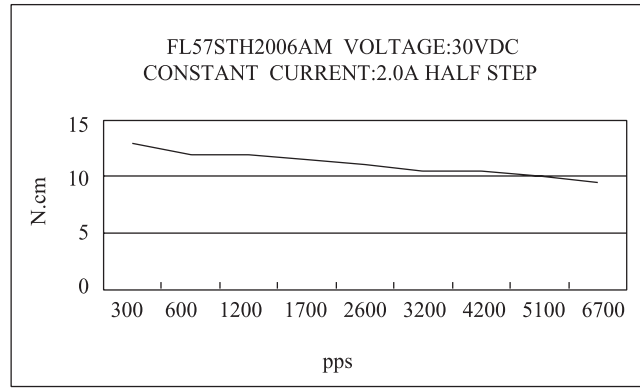

b

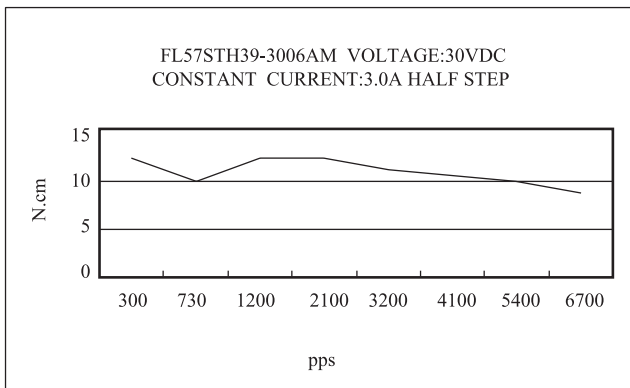

c

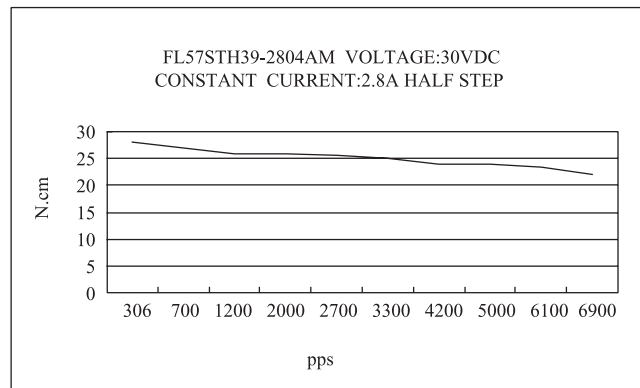

d

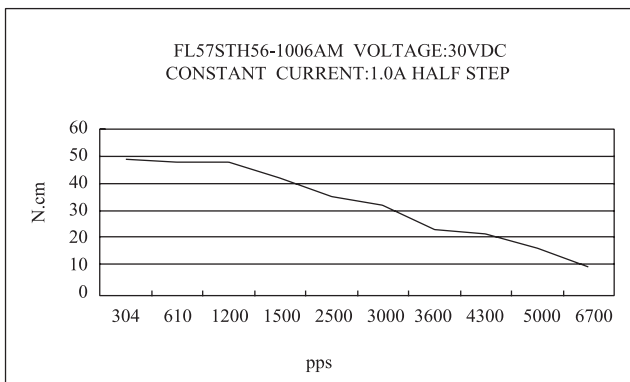

e

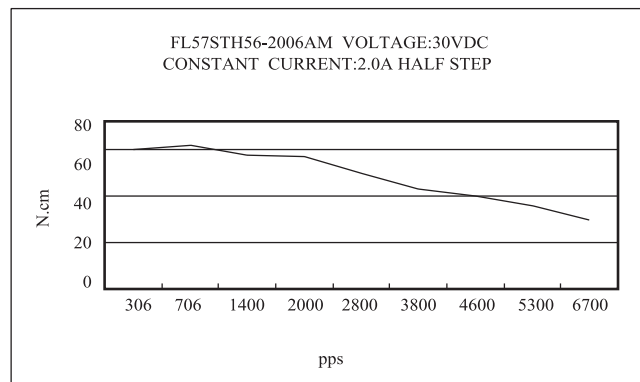

f

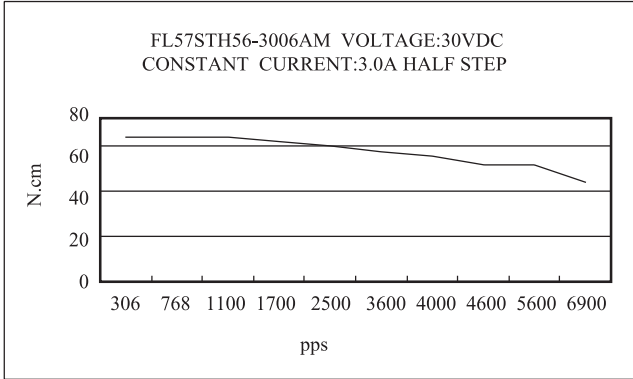

g

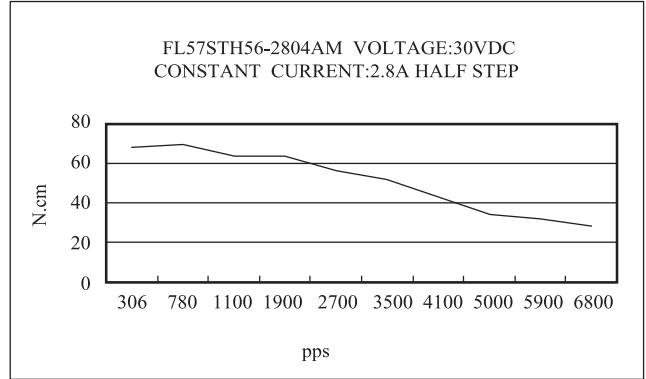

h

● Pull out Torque Curve

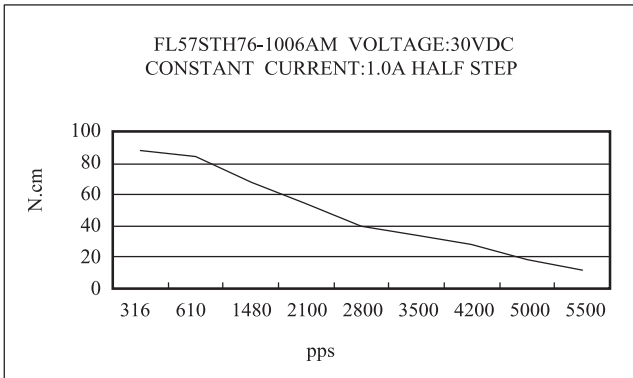

i

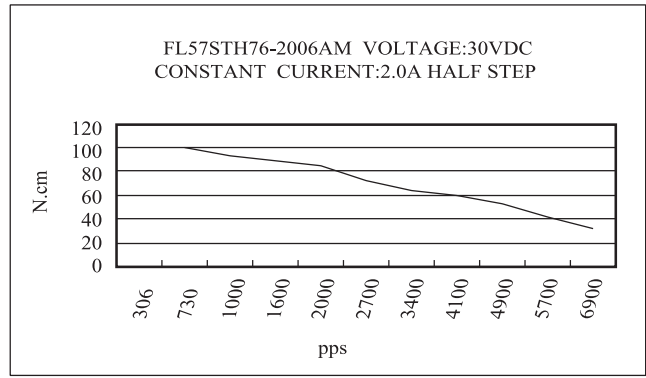

j

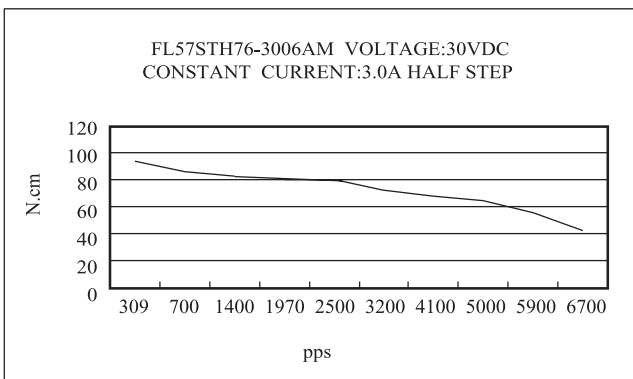

k

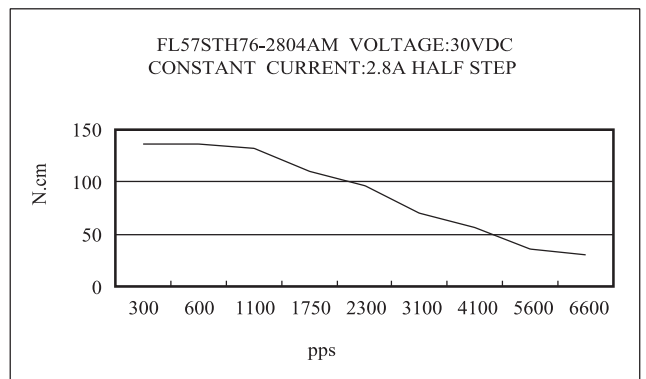

l