

IGBT Modules



V_{CES} 1200V
I_c 100A

Applications

- High frequency drivers
- Solar inverters
- UPS (Uninterruptible Power Supplies)
- Electric welding machine

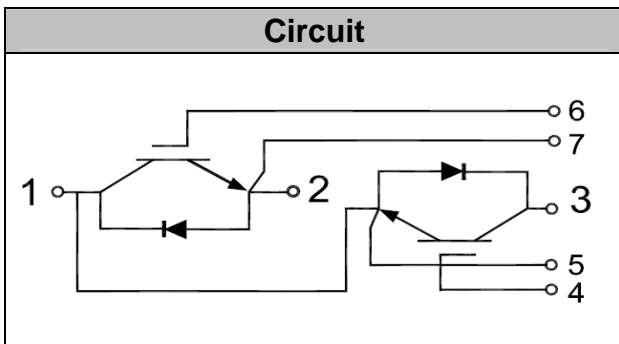

Features

- High speed IGBT in NPT technology
- Low switching losses
- High short circuit capability(10us)
- Including ultra fast & soft recovery anti-parallel FWD
- Low inductance

Absolute Maximum Ratings (T_C = 25°C unless otherwise specified)

Symbol	Description	Values	Units
V _{CES}	Collector - Emitter Voltage	1200	V
V _{GES}	Gate-Emitter Voltage	±20	V
I _C	DC Collector Current	T _C =25°C	150 A
		T _C =80°C	100 A
I _{CM(1)}	Peak Collector Current Repetitive	T _J = 125°C	200 A
I _F	Diode Continuous Forward Current	T _J = 125°C	100 A
P _D	Maximum Power Dissipation (IGBT)	T _C = 25°C, T _{Jmax} =150°C	675 W
T _J	Maximum Junction Temperature	150	°C
T _{JOP}	Operating Temperature	-40 ~ +150	°C
T _{stg}	Storage Temperature	-40 ~ +125	°C
Viso	Isolation Voltage (All Terminals Shorted)	f=50Hz, 1min	3000 V
Weight	Weight Of Module	155	g
Mounting Torque	Power Terminals Screw:M5	2.5~5	N*m
	Mounting Screw:M6	3~5	N*m

Notes :

(1) Repetitive Rating: Pulse width limited by max. junction temperature



Electrical Characteristics of IGBT ($T_J = 25^\circ\text{C}$ unless otherwise specified)

Symbol	Item	Conditions	Values			Units
			Min.	Typ.	Max.	
OFF Characteristics						
$V_{(BR)CES}$	Collector-Emitter Breakdown Voltage	$V_{GE}=0V, I_C=1mA$	1200			V
I_{CES}	Collector Leakage Current	$V_{CE}=V_{CES}, V_{GE}=0V,$			200	μA
		$V_{CE}=V_{CES}, V_{GE}=0V,$ $T_J=125^\circ\text{C}$			1	mA
I_{GES}	Gate Leakage Current	$V_{CE}=0V, V_{GE}=\pm 20V$	-400		400	nA
ON Characteristics						
$V_{GE(th)}$	Gate - Emitter Threshold Voltage	$V_{CE}=V_{GE}, I_C=4mA$	5	5.8	6.6	V
$V_{CE(sat)}$	Collector – Emitter Saturation Voltage	$I_C=100A, V_{GE}=15V$		3.0		V
		$I_C=100A, V_{GE}=15V,$ $T_J=125^\circ\text{C}$		3.8		V
Dynamic Characteristics						
C_{ies}	Input Capacitance	$V_{CE} = 25V, V_{GE} = 0V,$ $f = 1MHz$		6.7		nF
C_{oes}	Output Capacitance			1.1		nF
C_{res}	Reverse Transfer Capacitance			0.55		nF
Switching Characteristics						
$t_{d(on)}$	Turn-on Delay Time	$V_{CC} = 600V, I_C = 100A,$ $R_G = 10\Omega, V_{GE} = \pm 15V,$ Inductive Load, $T_J = 25^\circ\text{C}$		102		ns
t_r	Rise Time			79		ns
$t_{d(off)}$	Turn-off Delay Time			284		ns
T_f	Fall Time			24		ns
E_{on}	Turn-on Switching Loss			11.2		mJ
E_{off}	Turn-off Switching Loss			2.6		mJ
$t_{d(on)}$	Turn-on Delay Time	$V_{CC} = 600V, I_C = 100A,$ $R_G = 10\Omega, V_{GE} = \pm 15V,$ Inductive Load, $T_J = 125^\circ\text{C}$		110		ns
t_r	Rise Time			85		ns
$t_{d(off)}$	Turn-off Delay Time			325		ns
T_f	Fall Time			28		ns
E_{on}	Turn-on Switching Loss			15.6		mJ
E_{off}	Turn-off Switching Loss			3.8		mJ
R_{g-int}	Internal Gate Resistance			2.5		Ω
I_{SC}	SC data	$T_P \leq 10\mu\text{s}, V_{GE} = 15V,$ $V_{CC} = 600V, V_{CEM} \leq 1200V,$		700		A



Electrical Characteristics of FWD (T_C = 25°C unless otherwise specified)

Symbol	Item	Conditions		Values			Units
				Min.	Typ.	Max.	
V _{FM}	Forward Voltage	I _F = 100A, V _{GE} = 0V	T _J = 25°C		1.9		V
			T _J = 125°C		2.0		
Q _{rr}	Reverse Recovery Charge	I _F = 100A, di/dt = 1200A/μs, V _{rr} = 600V, V _{GE} = -15V	T _J = 25°C		5.6		μC
			T _J = 125°C		12.1		
I _{rr}	Peak Reverse Recovery Current		T _J = 25°C		78		A
			T _J = 125°C		95		
E _{rec}	Reverse Recovery Energy	T _J = 25°C		3.2		mJ	
		T _J = 125°C		6.7			

Thermal Resistance Characteristics

Symbol	Description	Values			Units
		Min.	Typ.	Max.	
R _{θJC}	Junction-To-Case (IGBT Part, Per Leg)		0.185		°C/W
R _{θJC}	Junction-To-Case (Diode Part, Per Leg)		0.3		°C/W
R _{θCS}	Case-To-Sink (Conductive Grease Applied)		0.05		°C/W

Performance Curves

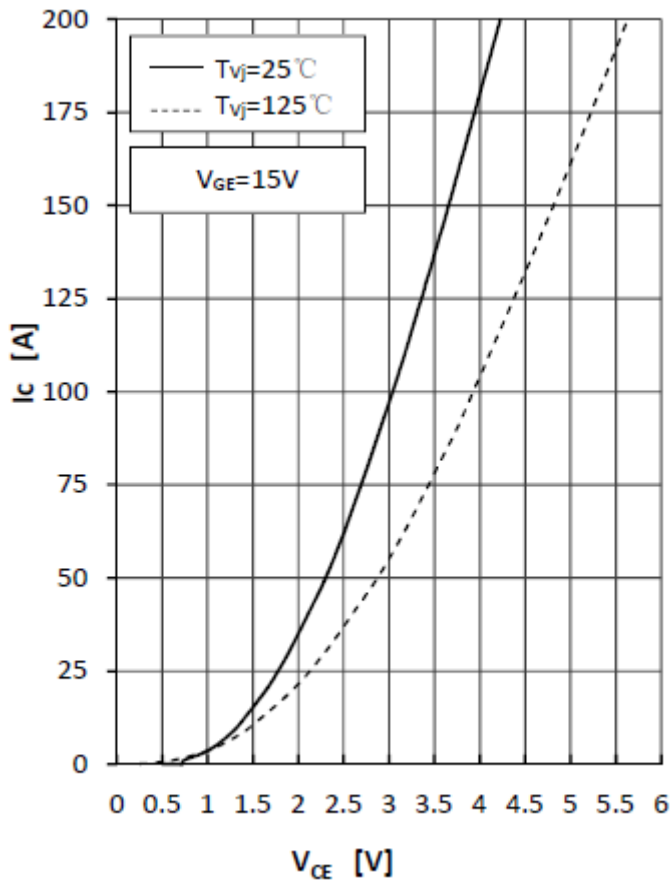

Fig1.IGBT Output Characteristics

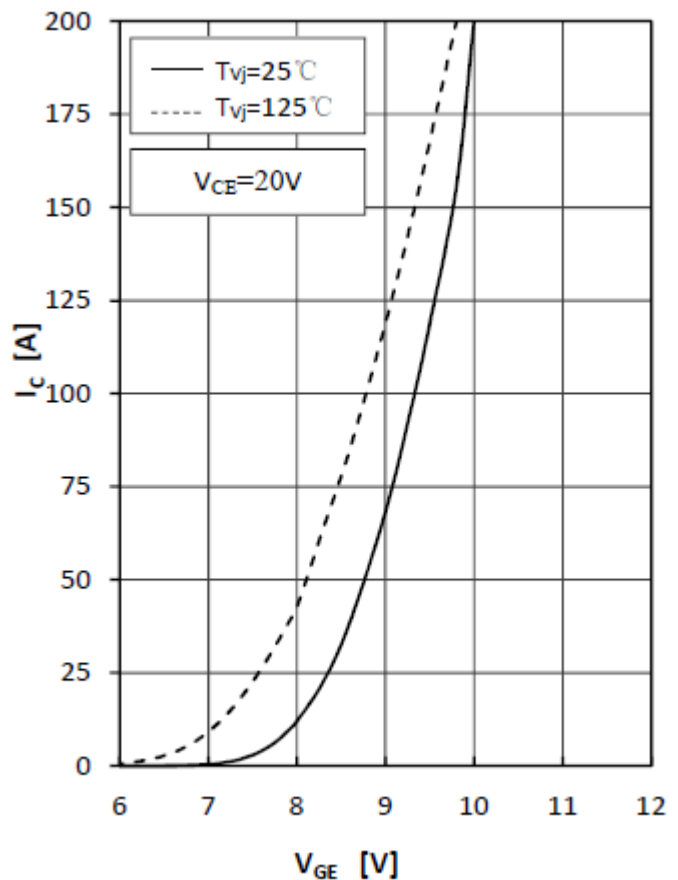

Fig2.IGBT Transfer Characteristics

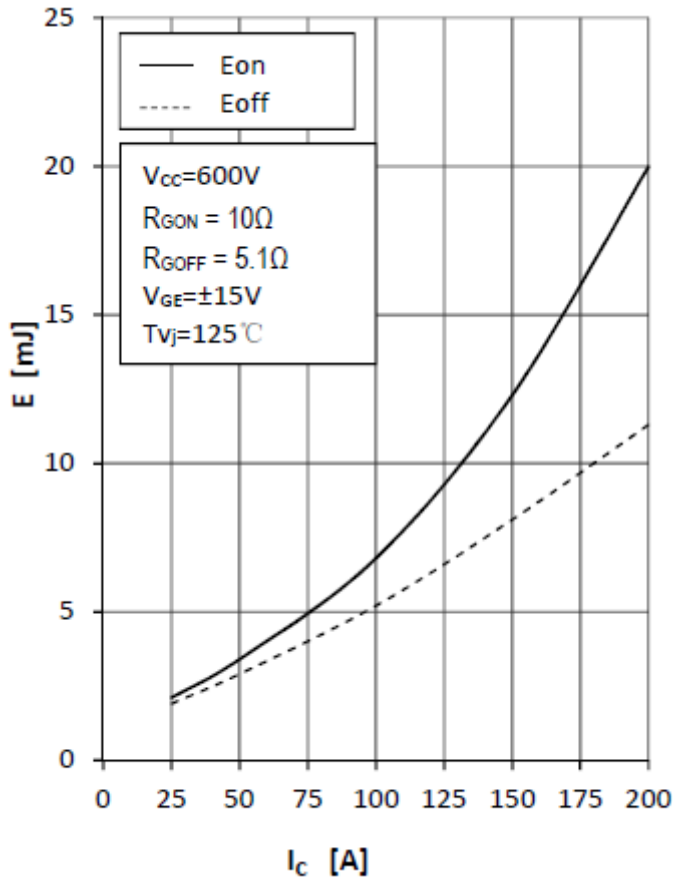

Fig3.IGBT Switching Loss vs.Ic

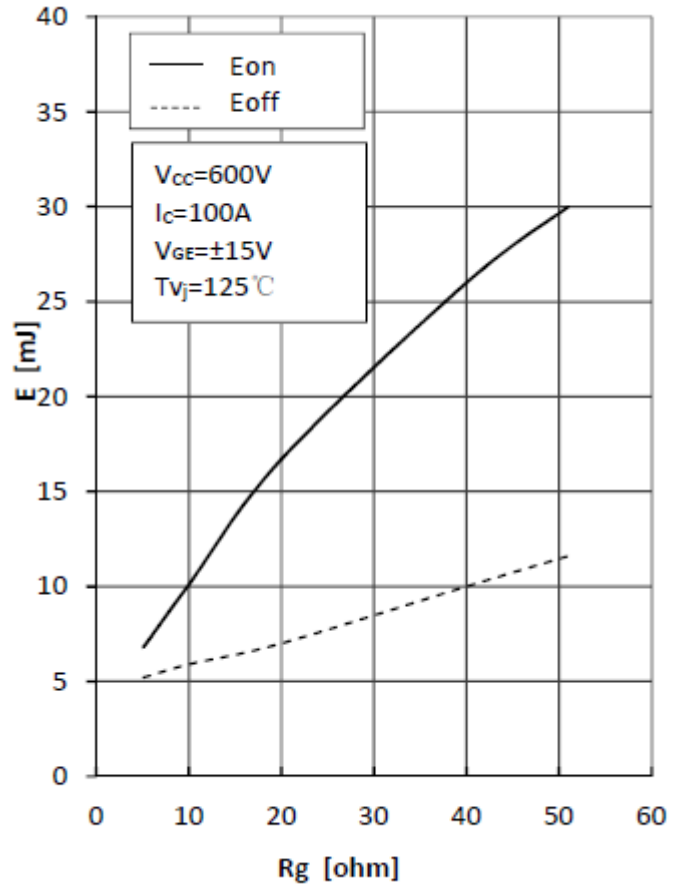

Fig4.IGBT Switching Loss vs.Rg

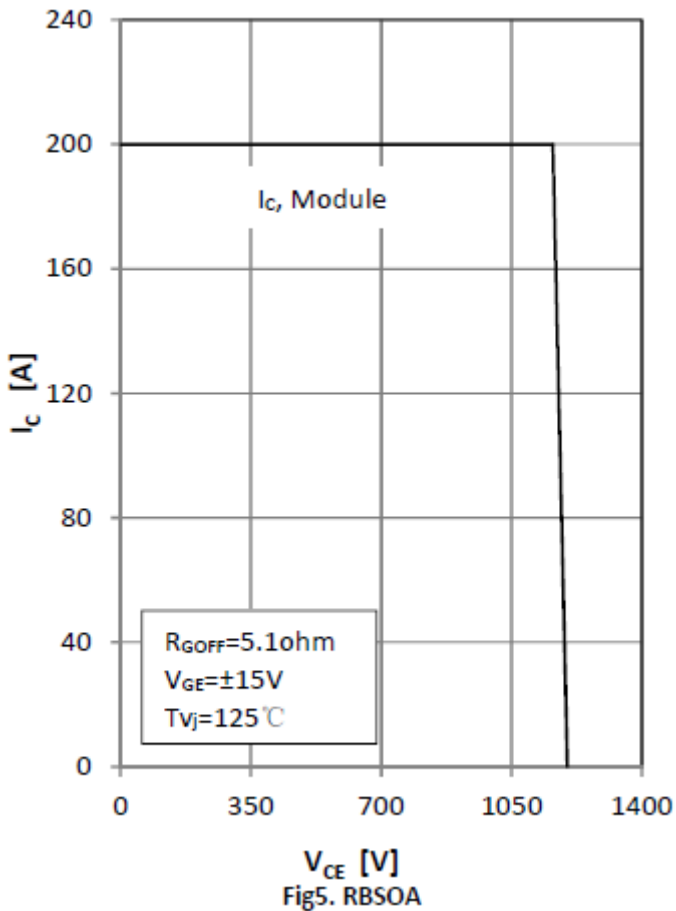

Fig5. RBSOA

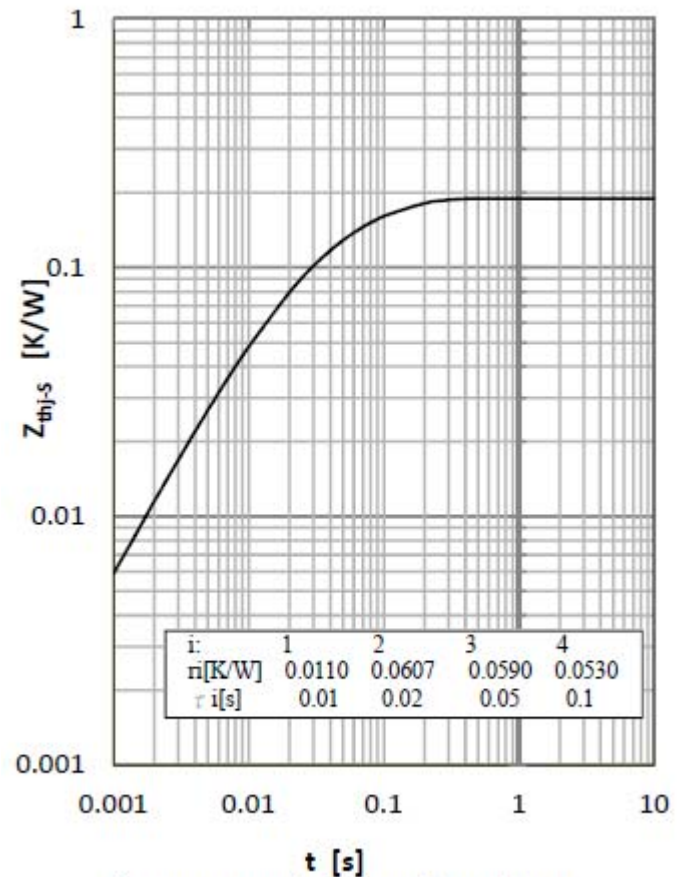

Fig 6. IGBT Transient Thermal Impedance

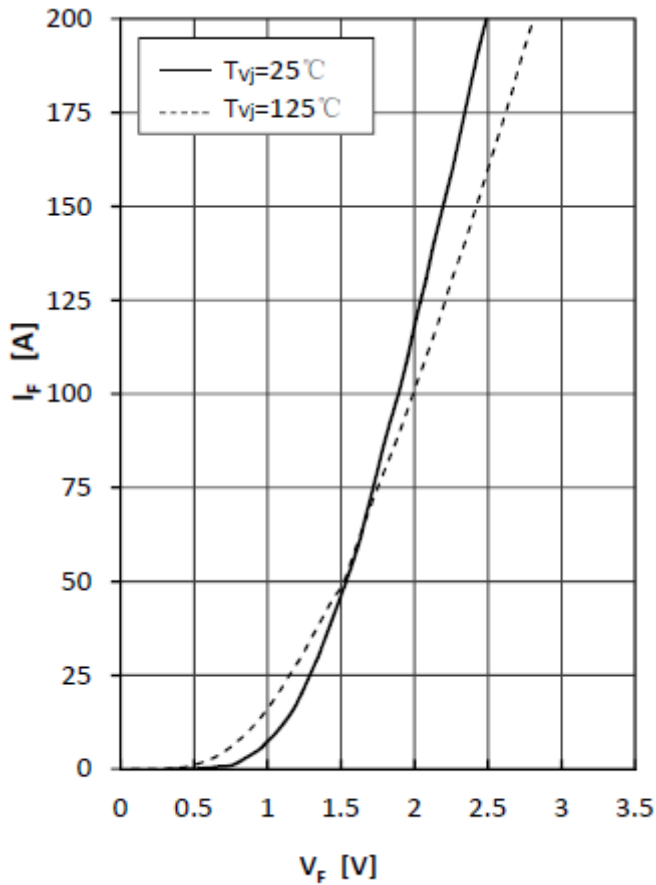

Fig7. Diode Forward Characteristics

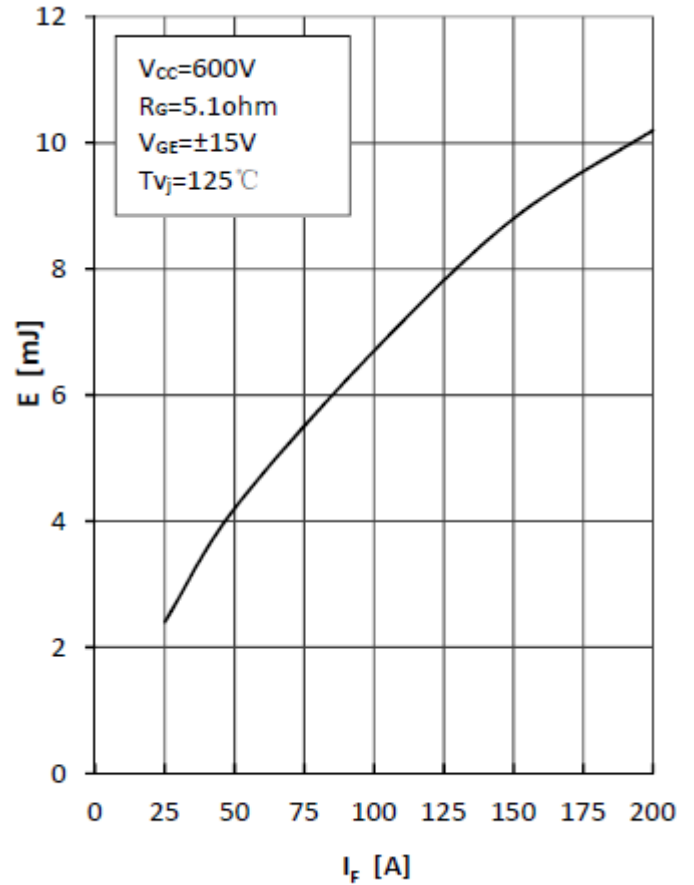

Fig8. Diode Switching Loss(Erec) vs. If

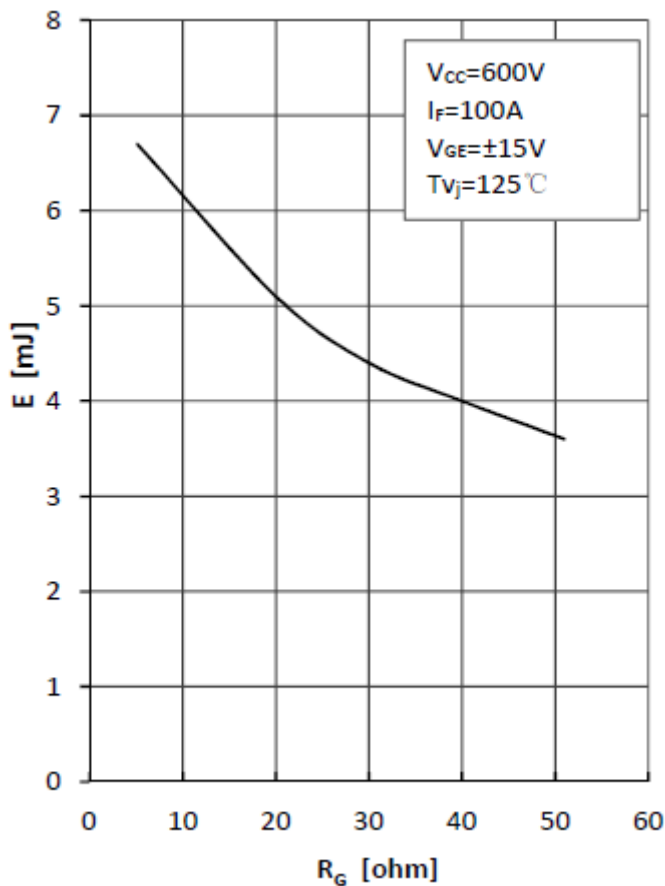

Fig9. Diode Switching Loss(Erec) vs. Rg

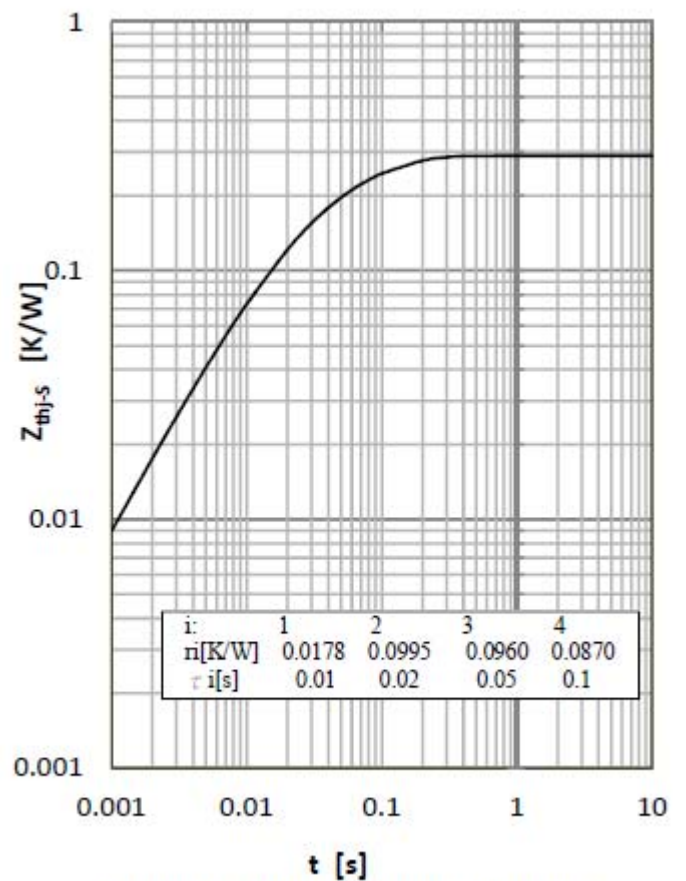
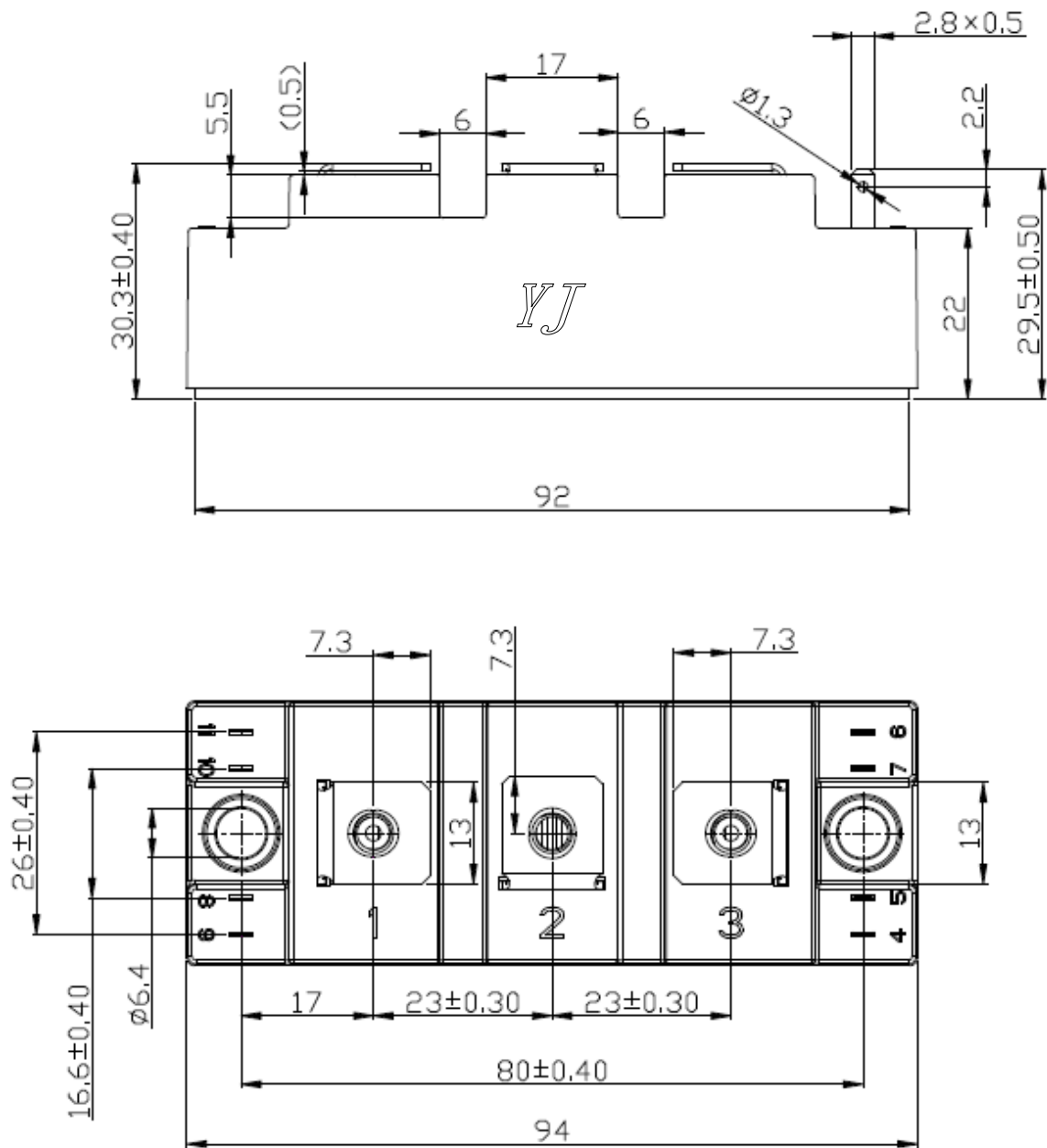

Fig10. Diode Transient Thermal Impedance



Package Outline Information

CASE: C1



Dimensions in mm